

Lithium Iron Phosphate Battery (LiFePO₄)

ESF24LFP180, 4.32kWh

Item	Unit	Specifications
		Value
Nominal capacity	Ah	180
Nominal voltage	V	24
Rated energy	Wh	4320
Min. op. voltage	V	22.4
Max. discharge current	A	1000
Recommended charging current	A	54
Standard charging time	h	4
Quick charging time	h	1
SOC range	%	10~90
Op. temperature charging	°C	0~45
Op. temperature discharging	°C	-20~55
Storage temperature	°C	-20~45
Weight	kg	51.00
Cycle life	(80DOD%)	≥1500
	(70DOD%)	≥2000
Packaging	Box	Aluminum
	Box	IP67
Charge management		BMS
Electric protection	Power connector	IP67
	Pre-charging circuit	Include
Communication		CAN
Output charger signal		CAN
		PWM
		TOR

ElecSys-France LFP Batteries :

- *designed for electric and hybrid vehicles and storage systems.*
- *connected with protected connectors against direct-contact to the High Voltage (HV).*
- *managed by a control board including BMS cards, security control system, dynamic control management of SOC, CAN, PWM charger signal, ignition signal, pre-charging circuit and an external 12V service.*

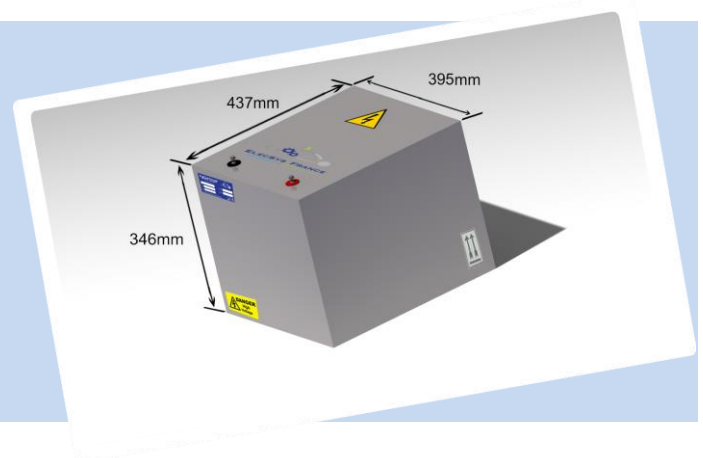

ELECSYS FRANCE SASU

453, Rue du Breuil - Technoland - 25460 ETUPES
Tél. +33 (0) 9 53 33 30 25 - Fax. +33 (0) 9 58 33 30 25
info@elecsys-france.com / www.elecsys-france.com

